

DAY FIVE

Circular Motion

Learning & Revision for the Day

- Concept of Circular Motion
- Dynamics of Uniform Circular Motion
- Forces in Circular Motion
- Applications of Centripetal and Centrifugal Forces

Concept of Circular Motion

Circular motion is a two dimension motion. To bring circular motion in a body it must be given some initial velocity and a force. Circular motion can be classified into two types- Uniform circular motion and Non uniform circular motion.

When an object moves in a circular path at a constant speed then the motion is said to be a **uniform circular motion**.

When an object moves in a circular path with variable speed, then the motion is said to be **non-uniform circular motion**.

Terms Related to Circular Motion

1. Angular Displacement

It is defined as the angle turned by the particle from some reference line. Angular displacement $\Delta\theta$ is usually measured in radians.

Finite angular displacement $\Delta\theta$ is a scalar but an infinitesimally small displacement is a vector.

2. Angular Velocity

It is defined as the rate of change of the angular displacement of the body.

From figure a particle moving on circular track of radius r is showing angular displacement $\Delta\theta$ in Δt time and in this time period, it covers a distance Δs along the circular track, then

$$\therefore \text{Angular velocity, } \omega = \lim_{\Delta t \rightarrow 0} \left(\frac{\Delta\theta}{\Delta t} \right) = \frac{d\theta}{dt}$$

It is an axial vector whose direction is given by the right hand rule. Its unit is rad/s.

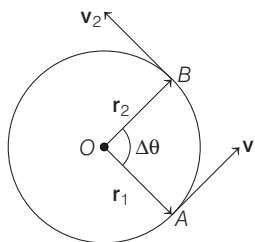

3. Angular Acceleration

It is the rate of change of angular velocity.

Thus,
$$\alpha = \frac{d\omega}{dt} = \frac{d^2\theta}{dt^2}$$

Its unit is rad/s^2 .

Dynamics of Uniform Circular Motion

If a particle, is performing circular motion with a uniform speed, then motion of the particle is called uniform circular motion. In such a case,

$$\frac{dv}{dt} = 0 \quad \text{and} \quad a_c = \omega^2 r = \frac{v^2}{r} \quad [\because v = r\omega]$$

Thus, if a particle moves in a circle of radius r with a uniform speed v , then its acceleration is $\frac{v^2}{r}$, towards the centre. This acceleration is termed as **centripetal acceleration**.

NOTE • In non-uniform circular motion Resultant acceleration of

$$\text{the body is } a = \sqrt{a_r^2 + a_t^2} = \sqrt{\frac{v^4}{r^2} + r^2 \alpha^2}$$

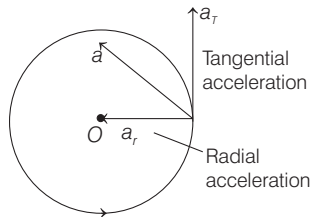

Forces in Circular Motion

In circular motion of an object two kinds of forces occur which are described below

Centripetal Force

The centripetal force is required to move a body along a circular path with a constant speed. The direction of the centripetal force is along the radius, acting towards the centre of the circle, on which the given body is moving.

Centripetal force,

$$F = \frac{mv^2}{r} = mr\omega^2 = mr \frac{4\pi^2 v^2}{T^2} \quad [\because v = r\omega]$$

Work done by centripetal force is always zero as it is perpendicular to velocity and hence instantaneous displacement.

Centrifugal Force

'Centrifugal force can be defined as the radially directed outward force acting on a body in circular motion, as observed by a person moving with the body.'

Mathematically, centrifugal force = $\frac{mv^2}{r} = mr\omega^2$ [$\because v = r\omega$]

Applications of Centripetal and Centrifugal Forces

Some of the most important applications of centripetal and centrifugal forces are given below

Motion of a Vehicle on a Level Circular Road

When a vehicle negotiates a circular path, it requires a centripetal force.

In such cases the lateral force of friction may provide the required centripetal force. Thus, for maintaining its circular path required centripetal force.

$$\left(\frac{mv^2}{r} \right) \leq \text{frictional force } (\mu mg)$$

Maximum speed $v_{\max} = \sqrt{\mu rg}$

where, μ = coefficient of friction between road and vehicle tyres and r = radius of circular path.

Bending of a Cyclist

When a cyclist goes round turns in a circular track, then angle made by cyclist with vertical level is given by

$$\begin{aligned} \tan \theta &= \frac{v^2}{rg} \approx \theta \\ &= \tan^{-1} \left(\frac{v^2}{rg} \right) \end{aligned}$$

Banking of a Curved Road

For the safe journey of a vehicle on a curved (circular) road, without any risk of skidding, the road is slightly raised towards its outer end.

Let the road be banked at an angle θ from the horizontal, as shown in the figure.

If b is width of the road and h is height of the outer edge of the road as compared to the inner edge, then

$$\tan \theta = \frac{v^2}{rg} = \frac{h}{b}$$

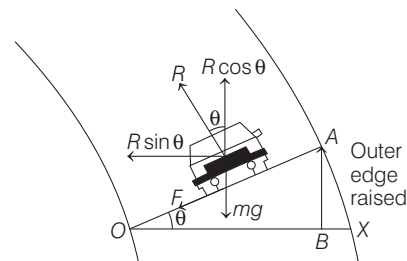

In case of friction is present between road and tyre, then Maximum speed,

$$v_{\max} = \sqrt{\frac{rg(\mu_s + \tan \theta)}{1 - \mu_s \tan \theta}}$$

where

μ_s = coefficient of static friction.

Motion of a Cyclist in a Death Well

For equilibrium of cyclist in a death well, the normal reaction N provides the centripetal force needed and the force of friction balances his weight mg .

Thus,
$$N = \frac{mv^2}{r}$$

and
$$f = \mu N = mg$$

$\Rightarrow v_{\max} = \sqrt{\frac{rg}{\mu}}$

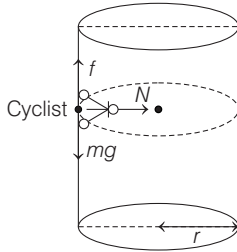

Motion along a Vertical Circle

In non-uniform circular motion speed of object decreases due to effect of gravity as the object goes from its lowest position A to highest position B .

- At the lowest point A , the tension T_L and the weight mg are in mutually opposite directions and their resultant provides the necessary centripetal force,

i.e. $T_L - mg = \frac{mv_L^2}{r}$ or $T_L = mg + \frac{mv_L^2}{r}$

- At the highest point B , tension T_H and the weight mg are in the same direction and hence,

$T_H + mg = \frac{mv_H^2}{r}$ or $T_H = \frac{mv_H^2}{r} - mg$

Moreover, v_L and v_H are correlated as $v_H^2 = v_L^2 - 2gr$.

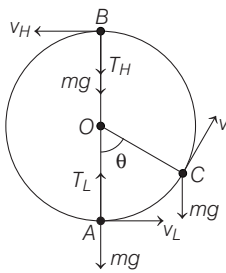

- In general, if the revolving particle, at any instant of time, is at position C , inclined at an angle θ from the vertical, then

$$v^2 = v_L^2 - 2gr(1 - \cos \theta)$$

and
$$T = mg \cos \theta + \frac{mv^2}{r}$$

- In the critical condition of just looping the vertical loop, (i.e. when the tension just becomes zero at the highest point B), we obtain the following results

$$T_H = 0, T_L = 6mg, v_L = \sqrt{5rg}$$

and
$$v_H = \sqrt{rg}$$

In general,
$$T_L - T_H = 6mg$$

- NOTE**
- When a vehicle is moving over a convex bridge, the maximum velocity $v = \sqrt{rg}$, where r is the radius of the road.
 - When the vehicle is at the maximum height, the reaction of the road, is $N_1 = mg - \frac{mv^2}{r}$

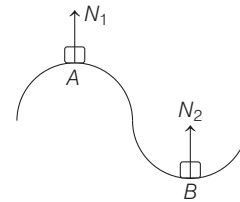

- When the vehicle is moving in a dip B , then
$$N_2 = mg + \frac{mv^2}{r}$$

DAY PRACTICE SESSION 1

FOUNDATION QUESTIONS EXERCISE

- 1 A particle is moving along a circular path of radius 5 m, moving with a uniform speed of 5 m s^{-1} . What will be the average acceleration, when the particle completes half revolution?

- (a) zero (b) $10/\pi \text{ ms}^{-2}$
(c) 10 ms^{-2} (d) None of these

- 2 A cyclist goes round a circular path of circumference 34.3 m in $\sqrt{22}$ s, the angle made by him with the vertical will be

- (a) 45° (b) 40° (c) 42° (d) 48°

- 3 A particle undergoes a uniform circular motion. About which point on the plane of the circle, will the angular momentum of the particle, remain conserved?

- (a) About centre of the circle
(b) On the circumference of the circle
(c) Inside the circle
(d) Outside the circle

- 4 A wheel is rotating at 900 rpm about its axis. When the power is cut-off, it comes to rest in 1 min. The angular retardation in rads^{-2} is

- (a) $\pi/2$ (b) $\pi/4$ (c) $\pi/6$ (d) $\pi/8$

- 5 A roller is made by joining together two corners at their vertices O . It is kept on two rails AB and CD which are placed symmetrically (see the figure), with its axis perpendicular to CD and its centre O at the centre of line joining AB and CD (see the figure). It is given a light path, so that it starts rolling with its centre O moving parallel to CD in the direction shown. As it moves, the roller will tend to **→ JEE Main 2016 (Offline)**

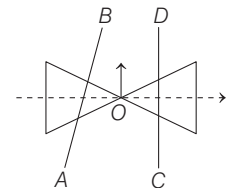

- (a) turn left (b) turn right
(c) go straight (d) turn left and right alternately

- 6 A particle moves in a circular path with decreasing speed. Choose the correct statement.
- Angular momentum remains constant
 - Acceleration \mathbf{a} is acting towards the centre
 - Particle moves in a spiral path with decreasing radius
 - The direction of angular momentum remains constant

- 7 A mass of 2 kg is whirled in a horizontal circle with the help of a string, at an initial speed of 5 rev/min. Keeping the radius constant, the tension in the string is doubled. The new speed is nearly

- 14 rpm
- 10 rpm
- 2.25 rpm
- 7 rpm

- 8 A cyclist is riding with a speed of 27 kmh^{-1} . As he approaches a circular turn on the road of radius 80 m, he applies brakes and reduces his speed at the constant rate of 0.5 ms^{-1} every second. What is the magnitude and direction of the net acceleration of the cyclist on the circular turn?

- 0.86 ms^{-2} at 54° to the velocity
- 0.6 ms^{-2} at 54° to the velocity
- 0.3 ms^{-2} at 75° to the velocity
- 0.7 ms^{-2} at 68° to the velocity

- 9 Two cars of masses m_1 and m_2 are moving in circles of radii r_1 and r_2 , respectively. Their speeds are such that they make complete circles in the same time t . The ratio of their centripetal acceleration is

→ AIEEE 2012

- $m_1 r_1 : m_2 r_2$
- $m_1 : m_2$
- $r_1 : r_2$
- 1 : 1

- 10 A ball of mass 0.25 kg attached to the end of a string of length 1.96 m is moving in a horizontal circle. The string will break if the tension is more than 25 N. What is the maximum speed with which the ball can be moved?

- 14 ms^{-1}
- 3 ms^{-1}
- 3.92 ms^{-1}
- 5 ms^{-1}

- 11 A car is moving along a straight horizontal road with a speed v_0 . If the coefficient of friction between the tyres and the road is μ , the shortest distance in which the car can be stopped is

- $\frac{v_0^2}{2\mu g}$
- $\frac{v_0}{\mu g}$
- $\left(\frac{v_0}{\mu g}\right)^2$
- $\frac{v_0}{\mu}$

- 12 A racing car travel on a track (without banking) ABCDEFA. ABC is a circular arc of radius $2R$. CD and FA are straight paths of length R and DEF is a circular arc of radius $R = 100 \text{ m}$. The coefficient of friction on the road is $\mu = 0.1$. The maximum speed of the car is 50 ms^{-1} . The minimum time for completing one round is

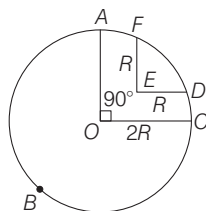

- 89.5 s
- 86.3 s
- 91.2 s
- 41.3 s

- 13 A cyclist starts from centre O of a circular park of radius 1 km and moves along the path $OPRQO$ as shown in figure. If he maintains constant speed of 10 ms^{-1} , what is his acceleration at point R in magnitude and direction?

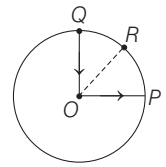

- 0.1 ms^{-2} along RO
- 0.01 ms^{-2} along OR
- 1 ms^{-2} along RO
- 0.1 rad s^{-2} along RO

- 14 A car is moving in a circular horizontal track of radius 10 m with a constant speed of 10 ms^{-1} . A plumb bob is suspended from the roof of the car by a light rigid rod of length 1.00 m. The angle made by the rod with the track is

- 60°
- 30°
- 45°
- zero

- 15 A frictionless track $ABCD$ ends in a semi-circular loop of radius R . A body slides down the track from point A which is at a height $h = 5 \text{ cm}$. Maximum value of R for the body to successfully complete the loop is

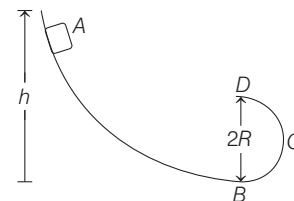

- 5 cm
- $\frac{15}{4} \text{ cm}$
- $\frac{10}{3} \text{ cm}$
- 2 cm

- 16 A weightless thread can bear a tension upto 3.7 kg-wt. A stone of mass 500 g is tied to it and revolved in a circular path of radius 4 m in a vertical plane. If $g = 10 \text{ ms}^{-2}$, then the maximum angular velocity of the stone will be

- 4 rad s^{-1}
- 16 rad s^{-1}
- $\sqrt{21} \text{ rad s}^{-1}$
- 2 rad s^{-1}

- 17 A bob of mass m suspended by a light string of length L is whirled into a vertical circle as shown in figure. What will be the trajectory of the particle, if the string is cut at B .

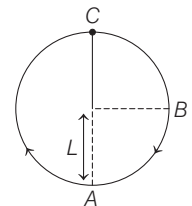

- Vertically upward
- Vertically downward
- Horizontally towards left
- Horizontally towards right

- 18 A particle is moving in a vertical circle. The tensions in the string when passing through two positions at angles 30° and 60° from vertical (lowest positions) are T_1 and T_2 , respectively. Then

- $T_1 = T_2$
- $T_2 > T_1$
- $T_1 > T_2$
- tension in the string always remains the same

- 19** A small body of mass m slides down from the top of a hemisphere of radius R . The surface of block and hemisphere are frictionless. The height at which the body lose contact with the surface of the sphere is
- (a) $\frac{3}{2}R$ (b) $\frac{2}{3}R$ (c) $\frac{1}{2}R$ (d) $\frac{1}{3}R$

Direction (Q. Nos. 20-24) *Each of these questions contains two statements : Statement I (Assertion) and Statement II (Reason). Each of these questions also has four alternative choices, only one of which is the correct answer. You have to select one of the codes (a), (b), (c), (d) given below :*

- (a) Statement I is true, Statement II is true; Statement II is the correct explanation for Statement I
 (b) Statement I is true, Statement II is true; Statement II is not the correct explanation for Statement I
 (c) Statement I is true; Statement II is false
 (d) Statement I is false; Statement II is true
- 20 Statement I** A car is moving in a horizontal circular plane with varying speed, then the frictional force is neither pointing towards the radial direction nor along the tangential direction.

Statement II Components of the frictional force are providing the necessary tangential and centripetal acceleration, in the above situation.

- 21 Statement I** A particle moving in a vertical circle, has a maximum kinetic energy at the highest point of its motion.
Statement II The magnitude of the velocity remains constant for a particle moving in a horizontal plane.
- 22 Statement I** The centripetal force and the centrifugal force never cancel out.
Statement II They do not act at the same time.
- 23 Statement I** Improper banking of roads causes wear and tear of tyres.
Statement II The necessary centripetal force in that event is provided by friction between the tyres and roads.
- 24 Statement I** When a particle moves in a circle with a uniform speed, there is a change in both its velocity and acceleration.
Statement II The centripetal acceleration in circular motion is dependent on the angular velocity of the body.

DAY PRACTICE SESSION 2

PROGRESSIVE QUESTIONS EXERCISE

- 1** A heavy sphere of mass m is suspended by a string of length l . The sphere is made to revolve about a vertical line passing through the point of suspension, in a horizontal circle such that the string always remains inclined to the vertical making an angle θ . What is the period of revolution?

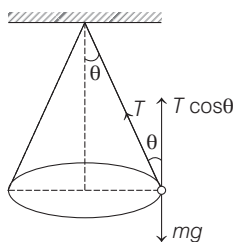

- (a) $T = 2\pi\sqrt{\frac{l}{g}}$ (b) $T = 2\pi\sqrt{\frac{l\cos\theta}{g}}$
 (c) $T = 2\pi\sqrt{\frac{l\sin\theta}{g}}$ (d) $T = 2\pi\sqrt{\frac{l\tan\theta}{g}}$

- 2** Two wires AC and BC are tied at C of small sphere of mass 5 kg, which revolves at a constant speed v in the horizontal circle of radius 1.6 m. The minimum value of v is

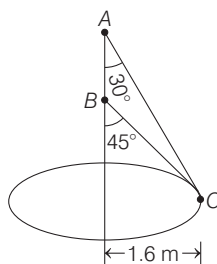

- (a) 8.01 ms^{-1}
 (b) 1.6 ms^{-1}
 (c) 0
 (d) 3.96 ms^{-1}

- 3** Two small spherical balls are free to move on the inner surface of the rotating spherical chamber of radius $R = 0.2 \text{ m}$. If the balls reach a steady state at angular position $\theta = 45^\circ$, the angular speed ω of device is

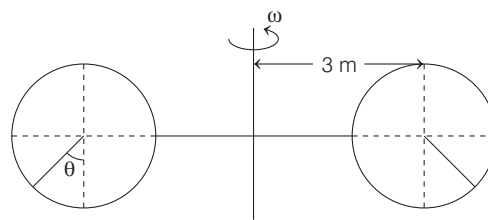

- (a) 8 rad s^{-1} (b) 2 rad s^{-1}
 (c) 3.64 rad s^{-1} (d) 9.34 rad s^{-1}

- 4** The skate board negotiates the circular surface of radius 4.5 m. At $\theta = 45^\circ$, its speed of centre of mass is 6 ms^{-1} . The combined mass of skate board and the person is 70 kg and his centre of mass is 0.75 m from the surface. The normal reaction between the surface and the skate board wheel is

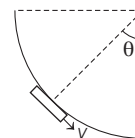

- (a) 500 N (b) 2040 N
 (c) 1157 N (d) zero

5 A particle is moving with a uniform speed in a circular orbit of radius R in a central force inversely proportional to the n th power of R . If the period of rotation of the particle is T , then

→ JEE Main 2018

- (a) $T \propto R^{3/2}$ for any n (b) $T \propto R^{\frac{n}{2}+1}$
 (c) $T \propto R^{(n+1)/2}$ (d) $T \propto R^{n/2}$

6 A bob of mass M is suspended by a massless string of length L . The horizontal velocity v at position A is just sufficient to make it reach the point B . The angle θ at which the speed of the bob is half of that at A , satisfies

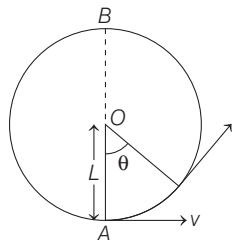

- (a) $\theta = \frac{\pi}{4}$ (b) $\frac{\pi}{4} < \theta < \frac{\pi}{2}$
 (c) $\frac{\pi}{2} < \theta < \frac{3\pi}{4}$ (d) $\frac{3\pi}{4} < \theta < \pi$

7 A roller coaster is designed such that riders experience 'weightlessness' as they go round the top of a hill whose radius of curvature is 20 m. The speed of the car at the top of the hill is between

- (a) 14 ms^{-1} and 15 ms^{-1} (b) 15 ms^{-1} and 16 ms^{-1}
 (c) 16 ms^{-1} and 17 ms^{-1} (d) 13 ms^{-1} and 14 ms^{-1}

8 Two particles revolve concentrically in a horizontal plane in the same direction. The time required to complete one revolution for particle A is 3 min, while for particle B is 1 min. The time required for A to complete one revolution relative to B is

- (a) 2 min (b) 1.5 min (c) 1 min (d) 1.25 min

9 A skier plans to ski on smooth fixed hemisphere of radius R . He starts from rest from a curved smooth surface of height $\left(\frac{R}{4}\right)$. The angle θ at which he leaves the hemisphere is

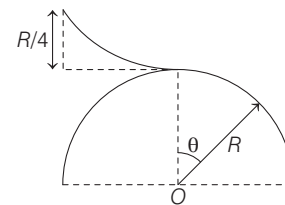

- (a) $\cos^{-1}\left(\frac{2}{3}\right)$ (b) $\cos^{-1}\left(\frac{5}{\sqrt{3}}\right)$
 (c) $\cos^{-1}\left(\frac{5}{6}\right)$ (d) $\cos^{-1}\left(\frac{5}{2\sqrt{3}}\right)$

10 A point moves along a circle with a speed $V = kt$, where $k = 0.5 \text{ m/s}^2$. Then total acceleration of the point at the moment when it has covered the n th fraction of the circle after the beginning of motion, where $n = \frac{1}{10}$

- (a) 0.8 m/s^2 (b) 1.2 m/s^2
 (c) 1.6 m/s^2 (d) 2.0 m/s^2

11 A circular tube of mass M is placed vertically on a horizontal surface as shown in the figure. Two small spheres, each of mass m , just fit in the tube, are released from the top. If θ gives the angle between radius vector of either ball with the verticle,

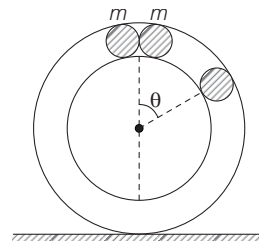

then for what value of the ratio $\frac{M}{m}$, tube breaks its contact with ground when $\theta = 60^\circ$. (Neglect any friction).

- (a) $\frac{1}{2}$ (b) $\frac{2}{3}$ (c) $\frac{\sqrt{3}}{2}$ (d) None of these

12 A particle is moving in a circle of radius R in such a way that at any instant the normal and tangential component of its acceleration are equal. if its speed at $t = 0$ is v_0 . The time taken to complete the first revolution is

- (a) $\frac{R}{v_0}$ (b) $\frac{R}{v_0} e^{-2\pi}$
 (c) $\frac{R}{v_0} (1 + e^{-2\pi})$ (d) $\frac{R}{v_0} (1 - e^{-2\pi})$

ANSWERS

SESSION 1	1 (b)	2 (a)	3 (a)	4 (a)	5 (a)	6 (c)	7 (d)	8 (a)	9 (c)	10 (a)
	11 (a)	12 (b)	13 (a)	14 (c)	15 (d)	16 (a)	17 (b)	18 (c)	19 (b)	20 (a)
	21 (d)	22 (c)	23 (a)	24 (b)						
SESSION 2	1 (b)	2 (d)	3 (c)	4 (c)	5 (c)	6 (d)	7 (a)	8 (b)	9 (c)	10 (a)
	11 (a)	12 (d)								

Hints and Explanations

SESSION 1

- 1** The change in velocity, when the particle completes half the revolution is given by

$$\Delta v = 5\text{ms}^{-1} - (-5\text{ms}^{-1}) = 10\text{ms}^{-1}$$

Now, the time taken to complete half the revolution is given by

$$t = \frac{\pi r}{v} = \frac{\pi \times 1}{1} = \pi \text{ s}$$

So, the average acceleration

$$= \frac{\Delta v}{t} = \frac{10}{\pi} \text{ms}^{-2}$$

- 2** Here, $2\pi r = 34.3 \Rightarrow r = \frac{34.3}{2\pi}$

$$\text{and } v = \frac{2\pi r}{T} = \frac{2\pi r}{\sqrt{22}}$$

Angle of banking,

$$\theta = \tan^{-1} \left(\frac{v^2}{rg} \right) = 45^\circ$$

- 3** In uniform circular motion, the only force acting on the particle is centripetal (towards centre). Torque of this force about the centre is zero. Hence, angular momentum about centre remains conserved.

- 4** Use $\omega = \omega_0 + \alpha t$... (i)

Here, $\omega_0 = 900 \text{rpm}$

$$= (2\pi \times 900)/60 \text{ rad s}^{-1}$$

$$\omega = 0 \text{ and } t = 60 \text{ s}$$

Then, Eq. (i) gives

$$\alpha = -\frac{\pi}{2} \text{ rad s}^{-2}$$

- 5** As, the wheel rolls forward the radius of the wheel decreases along AB , hence for the same number of rotations it moves less distance along AB , hence it turns left.

- 6** A particle moves in a spiral path with decreasing radius.

- 7** The tension in the string will provide necessary centripetal force.

$$\therefore T = m\omega^2 r = mr 4\pi^2 n^2$$

$$\therefore T \propto n^2$$

$$\Rightarrow \frac{T_1}{T_2} = \left(\frac{n_1}{n_2} \right)^2$$

$$\therefore \left(\frac{T}{2T} \right) = \left(\frac{5}{n_2} \right)^2$$

$$n_2^2 = 25 \times 2$$

$$n_2 = 5\sqrt{2} \approx 7 \text{ rpm}$$

- 8** Speed of the cyclist (v) = 27 kmh^{-1}

$$= 27 \times \frac{5}{18} \\ \left(\because 1 \text{ kmh}^{-1} = \frac{5}{18} \text{ ms}^{-1} \right) \\ = \frac{15}{2} \text{ ms}^{-1} = 7.5 \text{ ms}^{-1}$$

Radius of the circular turn (r) = 80 m

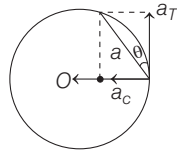

\therefore Centripetal acceleration acting on the cyclist

$$a_c = \frac{v^2}{r} = \frac{(15/2)^2}{80} = \frac{225}{4 \times 80} \text{ ms}^{-2} \\ = 0.70 \text{ ms}^{-2}$$

Tangential acceleration applied by brakes

$$a_T = 0.5 \text{ ms}^{-2}$$

Centripetal acceleration and tangential acceleration act perpendicular to each other.

\therefore Resultant acceleration,

$$a = \sqrt{a_c^2 + a_T^2} \\ = \sqrt{(0.7)^2 + (0.5)^2} \\ = \sqrt{0.49 + 0.25} \\ = \sqrt{0.74} = 0.86 \text{ ms}^{-2}$$

If resultant acceleration makes an angle θ with the direction of velocity, then

$$\tan \theta = \frac{a_c}{a_T} = \frac{0.7}{0.5} = 1.4 = \tan 54^\circ 28' \\ \theta = 54^\circ 28'$$

- 9** As their period of revolution is same, so, their angular speed is same centripetal acceleration is $a = \omega^2 r$.

$$\text{Thus, } \frac{a_1}{a_2} = \frac{\omega^2 r_1}{\omega^2 r_2} = \frac{r_1}{r_2}$$

- 10** As, $T = mv^2/r$

$$\text{Hence, } v = \sqrt{Tr/m} \\ = \sqrt{25 \times 1.96 / 0.25} = 14 \text{ ms}^{-1}$$

- 11** Retarding force,

$$F = ma = \mu R = \mu mg$$

$$a = \mu g$$

Now, from equation of motion,

$$v^2 = u^2 - 2as$$

$$\therefore 0 = u^2 - 2as$$

$$\text{or } s = \frac{u^2}{2a} = \frac{u^2}{2\mu g} = \frac{v_0^2}{2\mu g}$$

- 12** Balancing frictional force for centripetal force,

$$\frac{mv^2}{r} = f = \mu N = \mu mg$$

where, N is normal reaction

$$\therefore v = \sqrt{\mu rg}$$

(where, r is radius of the circular track)

For path ABC , Path length

$$= \frac{3}{4}(2\pi R) = 3\pi R = 3\pi \times 100$$

$$= 300\pi \text{ m}$$

$$v_1 = \sqrt{\mu 2 Rg}$$

$$= \sqrt{0.1 \times 2 \times 100 \times 10} = 14.14 \text{ ms}^{-1}$$

$$\therefore t_1 = \frac{300\pi}{14.14} = 66.6 \text{ s}$$

For path DEF , Path length

$$= \frac{1}{4}(2\pi R) = \frac{\pi \times 100}{2} = 50\pi$$

$$v_2 = \sqrt{\mu Rg} = \sqrt{0.1 \times 100 \times 10} \\ = 10 \text{ ms}^{-1}$$

$$t_2 = \frac{50\pi}{10} = 5\pi \text{ s} = 15.7 \text{ s}$$

For paths CD and FA ,

Path length = $R + R = 2R = 200 \text{ m}$

$$t_3 = \frac{200}{50} = 4.0 \text{ s}$$

\therefore Total time for completing one round

$$t = t_1 + t_2 + t_3 \\ = 66.6 + 15.7 + 4.0 = 86.3 \text{ s}$$

- 13** Acceleration of the cyclist at point R = centripetal

acceleration (a_c)

$$a_c = \frac{v^2}{r} = \frac{(10)^2}{1000} = \frac{100}{1000} \\ = 0.1 \text{ ms}^{-2}, \text{ along } RO$$

- 14** Centrifugal force on the rod,

$$F = \frac{mv^2}{r} \text{ along } BF.$$

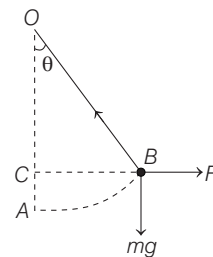

Let θ be the angle, which the rod makes with the vertical.

Forces parallel to the rod,

$$mg \cos \theta + \frac{mv^2}{r} \sin \theta = T$$

Force perpendicular to the rod

$$mg \sin \theta - \frac{mv^2}{r} \cos \theta$$

The rod would be balanced if

$$mg \sin \theta - \frac{mv^2}{r} \cos \theta = 0$$

$$mg \sin \theta = \frac{mv^2}{r} \cos \theta$$

$$\text{This gives } \tan \theta = \frac{v^2}{rg} = \frac{(10)^2}{10 \times 10}$$

$$= 1 = \tan 45^\circ$$

$$\text{Here } \theta = 45^\circ$$

15 Velocity at the bottom is $\sqrt{2gh}$

For completing the loop,

$$\sqrt{2gh} = \sqrt{5gR}$$

Hence, $R = 2h/5$

$$= (2 \times 5)/5 = 2 \text{ cm}$$

16 As, $T_{\max} = m\omega^2 + mg$

$$3.7 \times 10 = 0.5 \times 4\omega^2 + 0.5 \times 10$$

$$\text{or } \omega^2 = \frac{32}{2} = 16 \text{ or } \omega = 4 \text{ rad s}^{-1}$$

17 When bob is whirled into a vertical circle, the required centripetal force is obtained from the tension in the string. When string is cut, tension in string becomes zero and centripetal force is not provided, hence bob start to move in a straight line path along the direction of its velocity.

At point B, the velocity of B is vertically downward therefore, when string is cut at B, bob moves vertically downward.

$$\mathbf{18} \quad T = \frac{mv^2}{r} + mg \cos \theta$$

$$\therefore T \propto \cos \theta$$

$$\frac{T_1}{T_2} = \frac{\cos 30^\circ}{\cos 60^\circ} = \frac{\sqrt{3}/2}{1/2} = \frac{\sqrt{3}}{1}$$

$$\text{or } T_1 > T_2.$$

19 Suppose body slips at point B

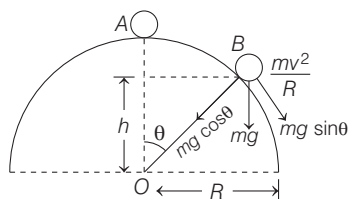

$$mg \cos \theta = \frac{mv^2}{R}$$

$$[\because v = \sqrt{2g(R-h)}]$$

$$g \cos \theta = \frac{2g(R-h)}{R}$$

$$\cos \theta = \frac{2(R-h)}{R}$$

$$\frac{h}{R} = \frac{2(R-h)}{R} \quad \left[\cos \theta = \frac{h}{R} \right]$$

$$\therefore h = \frac{2}{3} R$$

20 In the present case, the tangential component of frictional force is responsible for changing the speed of car while component along the radial direction is providing necessary centripetal force, hence net friction force is neither towards radial nor along tangential direction.

21 As the kinetic energy at the highest point is zero.

22 We know that centripetal and centrifugal forces act at the same time on two different bodies. Thus, they never cancel out.

23 If the roads are not properly banked, the force of friction between tyres and road provides the necessary centripetal force, which causes the wear and tear of tyres.

24 A particle in a circular motion has the shown feature. The velocity of particle in circular motion

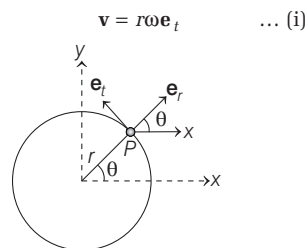

Thus, we see that velocity of the particle is $r\omega$ along e_t or in tangent direction. So, it changes as the particle rotates the circle. Acceleration of the particle

$$\mathbf{a} = -\omega^2 r e_r + \frac{dv}{dt} e_t \quad \dots \text{(ii)}$$

Thus, acceleration of a particle moving in a circle has two components one along e_t (along tangent) and the other along e_r (or towards centre). Of these the first one is called the tangential a_t and other is called centripetal a_r .

From Eq. (ii), it is obvious that acceleration depends on angular velocity (ω) of the body.

SESSION 2

$$\mathbf{1} \text{ Here, } \frac{mv^2}{r} = T \sin \theta \text{ and } mg = T \cos \theta$$

Dividing these two, we get

$$\tan \theta = \frac{v^2}{rg} = \frac{r\omega^2}{g} = \frac{4\pi^2 r}{gT^2}$$

$$\frac{\sin \theta}{\cos \theta} = \frac{4\pi^2}{gT^2} l \sin \theta \quad [\because r = l \sin \theta]$$

$$\Rightarrow T^2 = \frac{4\pi^2}{g} l \cos \theta$$

$$\Rightarrow T = 2\pi \sqrt{\frac{l \cos \theta}{g}}$$

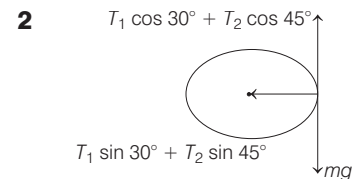

From the figure,

$$T_1 \cos 30^\circ + T_2 \cos 45^\circ = mg$$

$$T_1 \sin 30^\circ + T_2 \sin 45^\circ = \frac{mv^2}{r}$$

$$\Rightarrow T_1 = \frac{mg - \frac{mv^2}{r}}{(\sqrt{3} - 1)/2}$$

But $T_1 \geq 0$

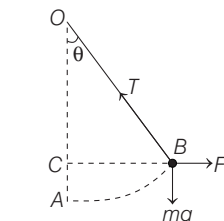

$$\frac{mg - \frac{mv^2}{r}}{\frac{\sqrt{3} - 1}{2}} \geq 0$$

$$\Rightarrow mg \geq \frac{mv^2}{r} \Rightarrow v \leq \sqrt{rg}$$

$$\therefore v_{\max} = \sqrt{rg} = \sqrt{1.6 \times 9.8} = 3.96 \text{ ms}^{-1}$$

3 Given, $R = 0.2 \text{ m}$

From the figure,

$$r = 3R + R \sin 45^\circ$$

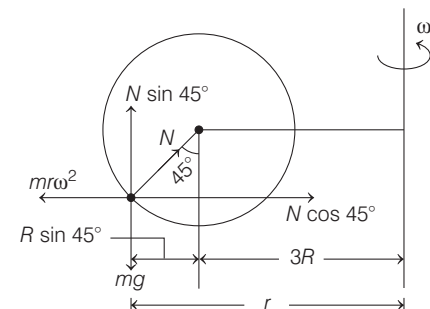

In the frame of rotating spherical chamber,

$$N \cos 45^\circ = m\omega^2$$

$$N \sin 45^\circ = mg$$

$$\Rightarrow \tan 45^\circ = \frac{mg}{m\omega^2 r} = \frac{g}{r\omega^2}$$

$$\Rightarrow \omega = \sqrt{\frac{g}{r}} = \sqrt{\frac{g}{3R + \frac{R}{\sqrt{2}}}} = 3.64 \text{ rad s}^{-1}$$

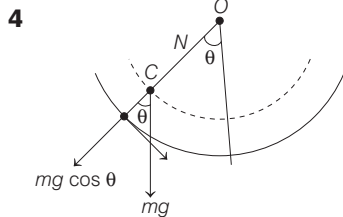

From the diagram,

$$N - mg \cos \theta = \frac{mv^2}{r}$$

$$\therefore N = \frac{mv^2}{r} + mg \cos \theta$$

From the figure,

$$\theta = 45^\circ, m = 70 \text{ kg}, g = 9.8 \text{ ms}^{-2},$$

$$v = 6 \text{ ms}^{-2}, r = CO = 4.5 - 0.75 = 3.75 \text{ m}$$

Putting these values in above equation, we get

$$N = 1157 \text{ N}$$

5 \therefore Force = Mass \times Acceleration = $m\omega^2 R$

$$\text{and given, } F \propto \frac{1}{R^n} \Rightarrow F = \frac{k}{R^n}$$

So, we have

$$\frac{k}{R^n} = m \left(\frac{2\pi}{T} \right)^2 R$$

$$\Rightarrow T^2 = \frac{4\pi^2 m}{k} \cdot R^{n+1} \Rightarrow T \propto R^{\frac{n+1}{2}}$$

6 Velocity of the bob at the point A

$$v = \sqrt{5gL} \quad \dots(i)$$

From conservation of energy,

i.e. KE + PE = constant

$$\Rightarrow \left(\frac{v}{2} \right)^2 = v^2 - 2gh \quad \dots(ii)$$

$$h = L(1 - \cos \theta) \quad \dots(iii)$$

Solving Eqs. (i), (ii) and (iii), we get

$$\cos \theta = -\frac{7}{8}$$

$$\Rightarrow \theta = \cos^{-1} \left(-\frac{7}{8} \right) = 151^\circ$$

i.e. $3\pi/4 < \theta < \pi$

7 Balancing the force, we get

$$Mg - N = M \frac{v^2}{R}$$

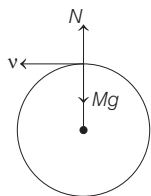

For weightlessness, $N = 0$

$$\therefore \frac{Mv^2}{R} = Mg \quad \text{or } v = \sqrt{Rg}$$

Putting the values,

$$R = 20 \text{ m}, g = 10 \text{ ms}^{-2}$$

$$\text{So, } v = \sqrt{20 \times 10} = 14.14 \text{ ms}^{-1}$$

Thus, the speed of the car at the top of the hill is between 14 ms^{-1} and 15 ms^{-1} .

8 Here, $(\omega_1 - \omega_2)t = 2\pi$ or $t = \frac{2\pi}{\omega_1 - \omega_2}$

$$\text{where, } \omega_1 = \frac{2\pi}{T_1} \text{ and } \omega_2 = \frac{2\pi}{T_2}$$

$$\therefore t = \frac{2\pi}{\left(\frac{2\pi}{T_1} - \frac{2\pi}{T_2} \right)} \text{ or } t = \frac{T_1 T_2}{T_2 - T_1} = \frac{3 \times 1}{3 - 1}$$

$$\text{or } t = 1.5 \text{ min}$$

Hence, (b) is the correct option.

9 At the time of leaving contact, normal reaction must be zero.

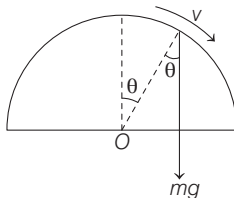

$$\text{i.e. } N = 0$$

$$\therefore mg \cos \theta = \frac{mv^2}{R} = \frac{m(2gh)}{R}$$

$$\text{or } \cos \theta = \frac{2h}{R}$$

$$\text{or } \cos \theta = \frac{2}{R} \left[\frac{R}{4} + R(1 - \cos \theta) \right]$$

$$\text{or } 3\cos \theta = \frac{5}{2} \text{ or } \cos \theta = \frac{5}{6}$$

$$\therefore \theta = \cos^{-1} \left(\frac{5}{6} \right)$$

Hence, (c) is the correct option.

10 $\therefore v = \frac{ds}{dt} = kt$

$$\therefore \int_0^s ds = k \int_0^t t dt \Rightarrow s = \frac{1}{2} kt^2 \quad \dots(i)$$

After completion of n^{th} fraction of circle

$$s = 2\pi rn \quad \dots(ii)$$

From Eqs. (i) and (ii), we get

$$t^2 = \left[\frac{4\pi rn}{k} \right]$$

Now, tangential acceleration,

$$a_t = \frac{dv}{dt} = \frac{d}{dt}(kt) = k$$

and normal acceleration,

$$a_n = \frac{v^2}{r} = \frac{k^2 t^2}{r}$$

$$\text{or } a_n = \frac{k^2}{r} \times \frac{4\pi rn}{k} = 4\pi nk$$

$$\therefore a = \sqrt{a_t^2 + a_n^2} = \sqrt{[k^2 + 16\pi^2 n^2 k^2]}$$

$$= k\sqrt{1 + 16\pi^2 n^2}$$

$$= 0.50 \sqrt{1 + 16 \times (3.14)^2 \times (0.1)^2}$$

$$= 0.8 \text{ m/s}^2$$

Hence, (a) is the correct option.

11 Speed of each particle at angle θ is

$$v = \sqrt{2gh}$$

[After applying conservation of energy]

where, $h = R(1 - \cos \theta)$

$$\therefore v = \sqrt{2gR(1 - \cos \theta)}$$

If N is normal reaction, then

$$N + mg \cos \theta = \frac{mv^2}{R}$$

$$\text{or } N + mg \cos \theta = \frac{m}{R} \times 2gR(1 - \cos \theta)$$

$$\text{or } N + mg \cos \theta = 2mg(1 - \cos \theta)$$

$$\text{or } N = 2m - 3mg \cos \theta \quad \dots(i)$$

The tube will break its contact with ground when,

$$2N \cos \theta \geq Mg$$

where, we put the value of N from Eq. (i)

is above relation, then we get

$$4mg \cos \theta - 6mg \cos^2 \theta = Mg$$

Put $\theta = 60^\circ$ (given)

$$\therefore 4mg \cos 60^\circ - 6mg \cos^2 60^\circ = Mg$$

$$\text{or } 2mg - \frac{3mg}{2} = Mg \Rightarrow \frac{M}{m} = \frac{1}{2}$$

Hence, (a) is the correct option.

12 Given, $a_t = a_r$

$$\text{or } \frac{dv}{dt} = \frac{v^2}{R} \text{ or } \frac{dv}{v^2} = \frac{1}{R} dt$$

$$\text{or } \int_{v_0}^v v^{-2} dv = \frac{1}{R} \int_0^t dt$$

$$\text{or } \left[\frac{1}{v_0} - \frac{1}{v} \right] = \frac{t}{R}$$

$$\text{or } \frac{1}{v} = \frac{1}{v_0} - \frac{t}{R} = \frac{R - v_0 t}{Rv_0}$$

$$\text{or } v = \frac{R \cdot v_0}{R - v_0 t}$$

$$\text{As } v = \frac{dx}{dt}$$

$$\therefore \frac{dx}{dt} = \frac{Rv_0}{R - v_0 t}$$

$$\text{or } \int_0^x dx = \int_0^t \frac{Rv_0}{R - v_0 t} dt$$

$$\text{or } x = Rv_0 \left(\frac{-1}{v_0} \right) [\ln(R - v_0 t)]_0^t$$

$$\text{or } x = -R \ln \left(1 - \frac{v_0 t}{R} \right)$$

$$\text{or } \ln \left(\frac{1 - v_0 t}{R} \right) = -\frac{x}{R}$$

$$\text{or } 1 - \frac{v_0 t}{R} = e^{-x/R}$$

$$\text{or } 1 - e^{-x/R} = \frac{v_0 t}{R}$$

$$\text{or } t = \frac{R}{v_0} (1 - e^{-x/R}).$$

After completing one revolution, $x = 2\pi R$

$$\therefore t = \frac{R}{v_0} (1 - e^{-2\pi}).$$

Hence, (d) is the correct option.